





10

JAKUZİ VE SPA EKİPMANLARI JACUZZI AND SPA EQUIPMENT

194-200

SPA&JAKUZİ GÖVDE VE JETLERİ



JETS AND TEE TRUNKS FOR SPA AND JACUZZIES

Ø32 mm HAVA VE Ø32 SU ÇIKIŞLI Ø32 mm AIR AND Ø32 WATER OUTLET

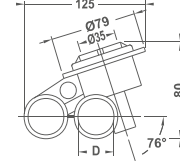

KOD CODE	MODEL MODEL	
43015123001	WF 1138	8.80 €

DAMLA MODEL JAKUZİ SETİ FACE EYEBALL SPA JET

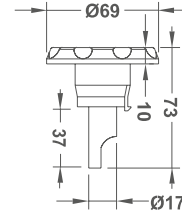

KOD CODE	MODEL MODEL	
43015123002	WF 1113B	7.70 €

ŞOK DUŞ SETİ BARB JET



KOD CODE	MODEL MODEL	
43015123004	WF 0054	9.90 €

DÖNER TIP Ø11 ½" JET CONTASIYLA Ø11 ½" FACE SWIRL JET WITH GASKET



KOD CODE	MODEL MODEL	
43015123005	WF 2206	8.80 €

Ø32 mm HAVA VE Ø50 SU ÇIKIŞLI Ø32 mm AIR AND Ø50 WATER OUTLET

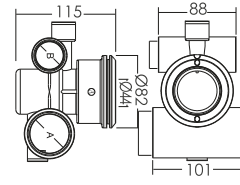

KOD CODE	MODEL MODEL	
43015123006	WF 0031	15 €

DÜZ GÖRÜNÜMLÜ (STANDART) JET SMOOTH FACE (SWIRL JET)

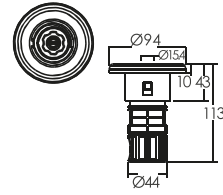

KOD CODE	MODEL MODEL	
43015123007	WF 0044	11 €

DÖNER TİP JET ROTARY TYPE JET

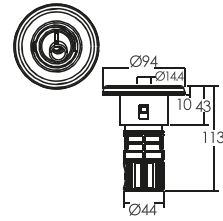

KOD CODE	MODEL MODEL	
43015123008	WF 0048	11 €

DAMLA MODEL DÖNER JET DROP TYPE ADJUSTABLE JET

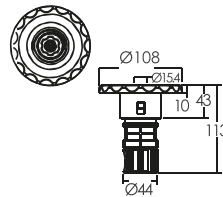

KOD CODE	MODEL MODEL	
43015123009	WF 0018	18.50 €

PNOMATİK BUTON PNEUMATIC BUTTON

- Jakuzi pompası veya blowerı açıp kapatmak için kullanılan butondur
- It is the button used for turning the jacuzzi pump or blower on and off

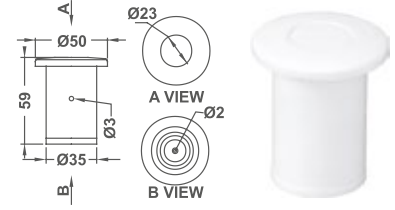

KOD CODE	MODEL MODEL	
43016123003	WF 1844 B-ABS	3.00 €
43016123004	WF-1844K-SS 304	

HAVA AYAR BUTONU AIR ADJUSTMENT BUTTON

- Jakuzi jetlerine hava verilmesini sağlayan butonlardır
- Hava seviyesi bu buton ile istenilen ölçüde ayarlanabilir
- It is the button that provides air to the jacuzzi jets
- Air level can be adjusted to the desired size with this button



KOD CODE	MODEL MODEL	
43016123005	WF 1834 B	5.00 €
43016123001	WF 1835	6.00 €

DOKUZ DELİKLİ BLOWER NOZULU NINE HOLE NOZZLE

- Blowerdan gelen havanın çıkışını sağlayan nozullardır
- The nozzles that provide air outlet, coming from the blower

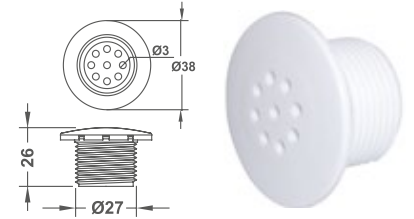

KOD CODE	MODEL MODEL	
43016123002	WF 2211 B	4.00 €

BLOWER NOZULU AIR BLOWER NOZZLE

- Blowerdan gelen havanın çıkışını sağlayan nozullardır
- The nozzles that provide air outlet, coming from the blower

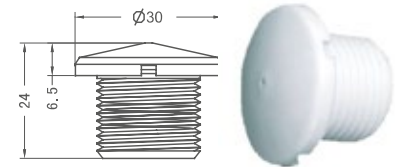

KOD CODE	MODEL MODEL	
43016123007	WF 2209	2 €

JAKUZİ EMİŞ SÜZGEÇLERİ

JACUZZIE DRAINS



EMİŞ SÜZGEÇİ 50 mm

DRAIN 50 mm

- Jakuzideki suyun tahliye edilmesini sağlarlar
- Provides discharge of water in the jacuzzi

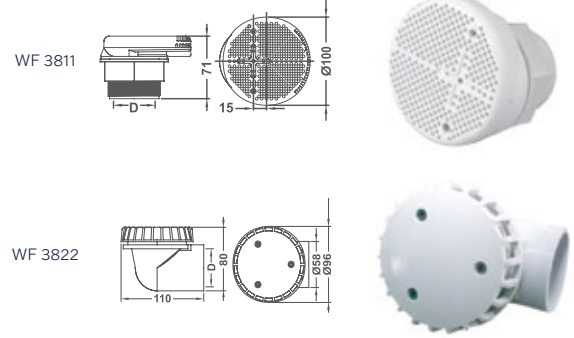

KOD CODE	MODEL MODEL	ÜRÜN TANIMI DESCRIPTION	
43017123001	WF 3811	Delikli Perforated	22.00 €
43017123002	WF 3822 B	Yapıştırırmalı Cemented	23.10 €

JAKUZİ KOLLEKTÖRLERİ

JACUZZIE COLLECTORS



- Hava ve/veya suyu dağıtmak için tesisatta kullanılan kollektörlerdir
- Ø 10 mm hava girişi, Ø 15 mm su girişi
- Collectors are used in the installation to distribute air and water
- Ø 10 mm air inlet, Ø 15 mm water inlet

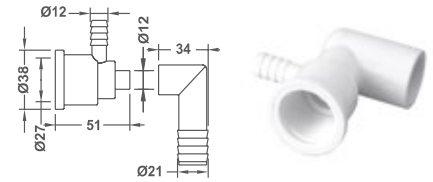

KOD CODE	MODEL MODEL	
43018123001	WF 2201 B	4.40 €

- Hava ve/veya suyu dağıtmak için tesisatta kullanılan kollektörlerdir
- Ø 40 mm x 50 mm x 20 mm 4 su çıkışlı kollektör
- Collectors are used in the installation to distribute air and water
- Collector with 4 port water outlets Ø 40 mm x 50 mm x 20 mm

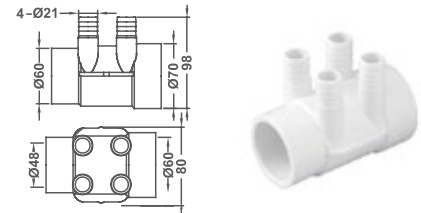

KOD CODE	MODEL MODEL	
43018123002	WF 1824	16,50 €

- Hava ve/veya suyu dağıtmak için tesisatta kullanılan kollektörlerdir
- Ø 25 mm x 10 mm ve 4 hava çıkışlı kollektör

- Collectors are used in the installation to distribute air and water
- Collector with Ø 25 mm x 10 mm and 4 port air outlets

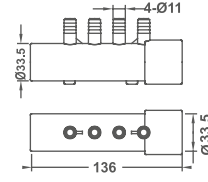

KOD	MODEL	
CODE	MODEL	
43018123003	WF 1825	18.70 €

- Hava ve/veya suyu dağıtmak için tesisatta kullanılan kollektörlerdir
- Ø 40 mm x 10 mm ve 8 hava çıkışlı kollektör

- Collectors are used in the installation to distribute air and water
- Collector with Ø 40 mm x 10 mm and 8 port air outlets



KOD	MODEL	
CODE	MODEL	
43018123004	WF 1865	19.80 €

- Hava ve/veya suyu dağıtmak için tesisatta kullanılan kollektörlerdir
- Ø 40 mm x 20 mm ve 8 hava çıkışlı kollektör

- Collectors are used in the installation to distribute air and water
- Collector with Ø 40 mm x 20 mm and 8 port air outlets



KOD	MODEL	
CODE	MODEL	
43018123005	WF 1864	22 €

JAKUZİ HORTUMLARI

FLEXIBLE JACUZZI HOSES



- PVC'den üretilmiştir
- Esnekliği sayesinde dairesel yapılarda kolay montaj imkanı tanır
- 25 metre rulo uzunluğu
- Made of PVC
- Thanks to its flexibility, it allows easy assembly in circular structures
- 25 meters roll length



KOD	ÇAP mm	
CODE	DIA mm	
43019002001	32	7.50 €/mt
43019002002	50	11.50 €/mt
43019002003	63	12.50 €/mt
43019002005	75	22 €/mt
43019002004	90	23 €/mt

JAKUZİ HAVA BLOWERİ

JACUZZI AIR BLOWER



- Enerji sarfiyatı düşüktür
- Kompakt tasarımı sayesinde sınırlı alanlarda dahi kullanıma uygundur
- With low energy consumption
- Thanks to its compact design, it is suitable for use even in limited spaces



KOD CODE	MODEL MODEL	WATT WATT	
43021123001	EB 350	220V - 350W	85 €
43021123003	EB 450	220V - 450W	90 €
43021123002	EB 550	220V - 550W	95 €

BLOWER WF MODEL

BLOWER WF MODEL



- Alüminyum alaşımdan üretilmiştir
- Kuru hava transferi için uygundur
- Sürekli çalışmaya uygun olarak dizayn edilmiştir
- Dik veya yatay şekilde montaj edilebilir
- Bakım maliyeti düşüktür
- Kolay montajı ve sessiz çalışması sayesinde büyük avantaj sağlar
- 50 Hz ve 60 Hz de çalışabilen trifaze motorludur

- Made of aluminum alloy
- Suitable for dry air transfer
- Designed for continuous duty
- Can be mounted vertically or horizontally
- Maintenance cost is low
- It provides great advantage thanks to its easy installation and quiet operation
- It has three-phase motor that can work at 50 Hz and 60 Hz



KOD CODE	MODEL MODEL	FAZ PHASE	BAĞLANTI Ø CONNECTION Ø	
16017124006	1,1 kW MONO WF	III	2"	340 €
16017124007	1,3 kW MONO WF	III	2"	350 €
16017124008	1,5 kW MONO WF	III	2"	400 €
16017124009	2,2 kW MONO WF	III	2"	490 €
16017124010	1,1 kW TRI WF	III	2"	320 €
16017124010	1,3 kW TRI WF	III	2"	330 €
16017124012	1,5 kW TRI WF	III	2"	390 €
16017124013	2,2 kW TRI WF	III	2"	480 €

BLOWER YEDEKLERİ

BLOWER PARTS



KOD CODE	TANIM DESCRIPTION	
49811122001	2- Emiş Takımı (İtalya) Suction Kid (Italy)	65 €
16017124015	1- Emiş Nozulu Suction Nozzle Waterfun	40 €
16017124014	Susturucu Silencer Waterfun	40 €